

User Manual

Revision V1.1 September 2012



EC150 Touch Monitor



Warning! It will cause malfunction if the monitor is operating with unspecified power supply unit or incorrect power voltage. Do not exposure this unit in the rain or moisture environment to reduce the risk of fire or electric shock.

Content:

I. FCC Warning Statement.....	2
II. Introduction	3
<input type="checkbox"/> Features.....	3
<input type="checkbox"/> Unpacking the monitor	4
III. Installation	5
<input type="checkbox"/> I/O placement.....	5
<input type="checkbox"/> To PC	6
<input type="checkbox"/> Touch Driver installation	7
<input type="checkbox"/> MSR installation (optional)	9
<input type="checkbox"/> VFD (optional).....	11
<input type="checkbox"/> Control Buttons	13
<input type="checkbox"/> Structure of OSD settings.....	14
IV. For your safety	15
V. Support timing chart:.....	15
VI. Mechanical Dimension.....	16
VII. Product General Specification	17

I. FCC Warning Statement

WARNING

Note: This equipment has been tested and found to comply with the limits for a Class B digital device, pursuant to Part 15 of FCC Rules. These limits are designed to provide reasonable protection against harmful interference in a residential installation. This equipment generates, uses and can radiate radio frequency energy and, if not installed and used in accordance with the instruction, may cause harmful interference to radio communications. However, there is no guarantee that interference will not occur in a particular installation. If this equipment does cause harmful interference to radio or television reception, which can be determined by turning the equipment off and on, the user is encouraged to try to correct the interference by one or more of the following measures:

- Reorient or relocate the receiving antenna.
- Increase the separation between the equipment and receiver.
- Connect the equipment into an outlet on a circuit different from that to which the receiver is connected.
- Consult the dealer or an experienced radio/TV technician for help.

Notice:

- (1) A Unshielded-type power cord is required in order to meet FCC emission limits and also to prevent interference to the nearby radio and television reception. It is essential that only the supplied power cord be used.*
- (2) Use only shielded cables to connect I/O devices to this equipment.*
- (3) Changes or modifications not expressly approved by the party responsible for compliance could void the user's authority to operate the equipment.*

II. Introduction

Touch Dynamic's EC150 is color TFT LCD monitor, integrate with resistive touch, suitable for many types of applications.

➤ Features

- Optimal display resolution 1024 * 768
- VESA 75 * 75 mm wall mount standard
- Durable and sturdy base design
- Optional 3 tracks Magnetic Strip Reader (MSR)
- Optional Rear Customers Display
- DVI-D or VGA interface
- Serial or USB touch Interface
- Adjustable viewing angel freely up to 90 degrees horizontally
- Low power consumption only 20W with CCFL backlight

➤ Unpacking the monitor

- Put the monitor on a clean surface, make sure the box in upright position.
- Remove packing materials from inside of box.

Check accessory

Please make sure all the accessory are included:

Standard Items

a.



b.



c.



d.



e.



f.



a. LCD Monitor

b. VGA cable

c. Touch driver / User Manual CD

d. Touch cable (USB or Serial Type)

e. Power adaptor

f. Power cable

Optional Items

g.



h.



g. MSR (USB Interface)

h. Customers Display

III. Installation

➤ I/O placement



1



2



3



4



5



6



7

- | | | | |
|---|--------------------------|---|------------|
| 1 | DC JACK | 2 | DVI |
| 3 | VGA | 4 | USB B Type |
| 5 | Dual USB A Type | 6 | RS232 |
| 7 | RJ45 (+12V for VFD ONLY) | | |

Warning : Please do not plug non-powered peripheral devices (e.g. printers, scanners etc) into the powered COM ports- as you can permanently damage your device!

➤ To PC

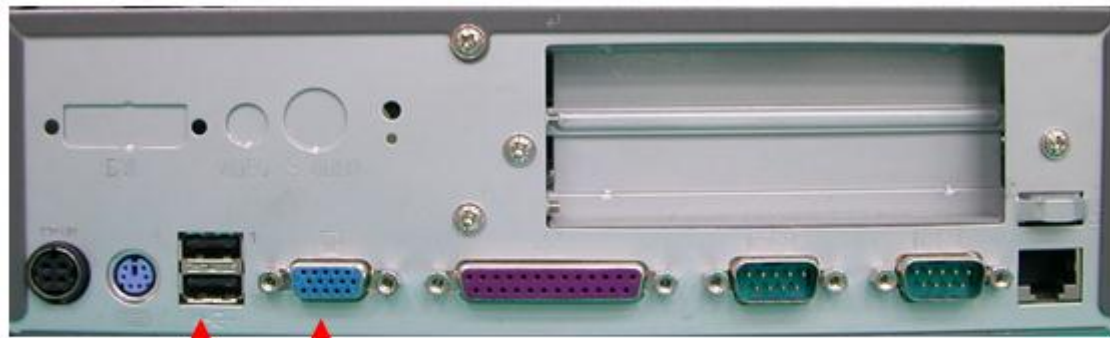

Touch+ ↕ VGA ↕

1. Connect VGA cable from monitor to PC
2. Connect USB touch cable to PC (Connect to the Serial port if you have serial interface touch)
3. Connect DC plug to monitor and the other side to wall outlet

➤ **Touch Driver installation**

Please download the driver from [Touch Dynamic's website](#)



1. Double click "setup.exe" from driver menu

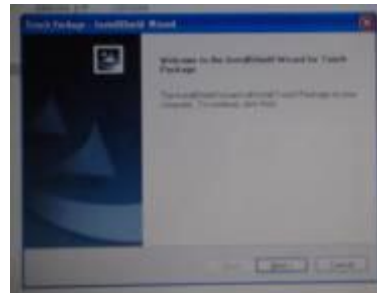

2. Click "next" from welcome window



3. Click "next" from choose destination location window



4. Click "next" from ready to install the program



5. Click "next" from setup type

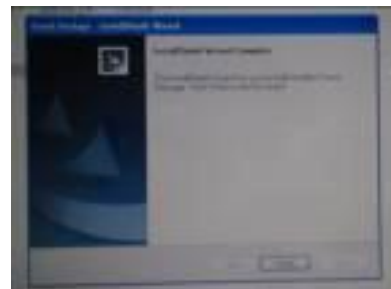

6. Click "finish" when setup completed

Calibration procedures:



1. Double click "POS Touch+" icon to run calibration function

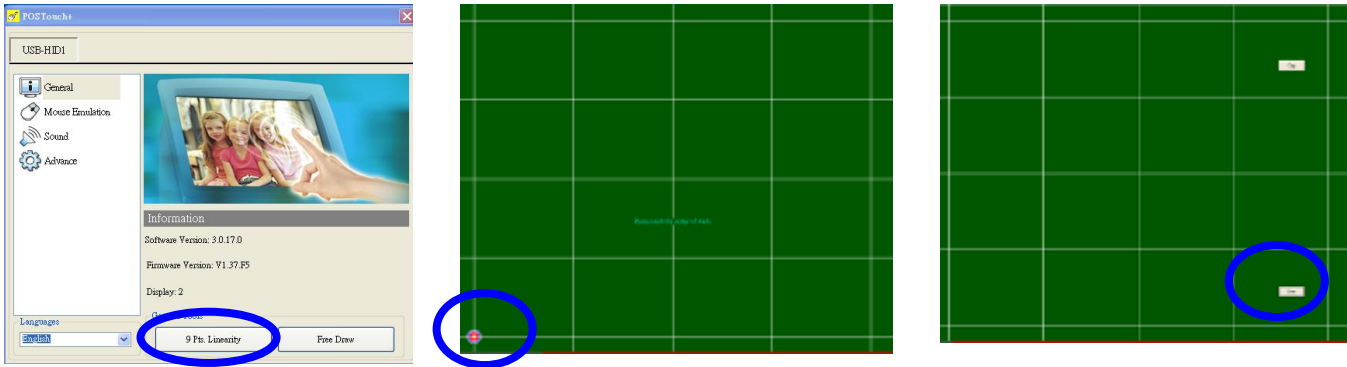

2. Follow 9 points linearity calibration procedures and save the data

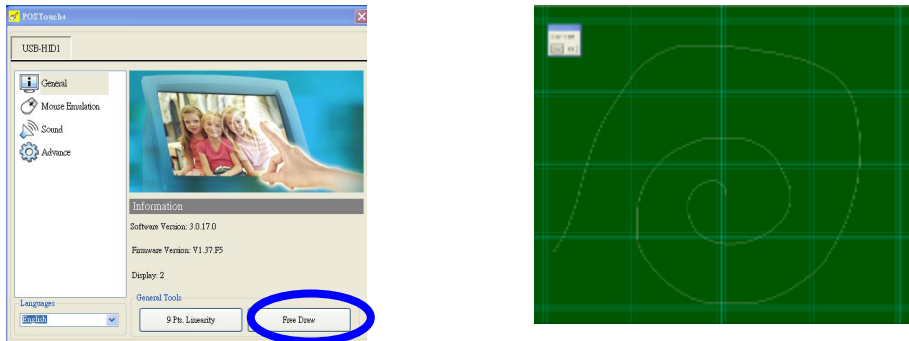

3. Follow free draw calibration
4. Exit calibration menu
5. Reboot PC

➤ **MSR installation (optional)**

Components of MSR Kit:

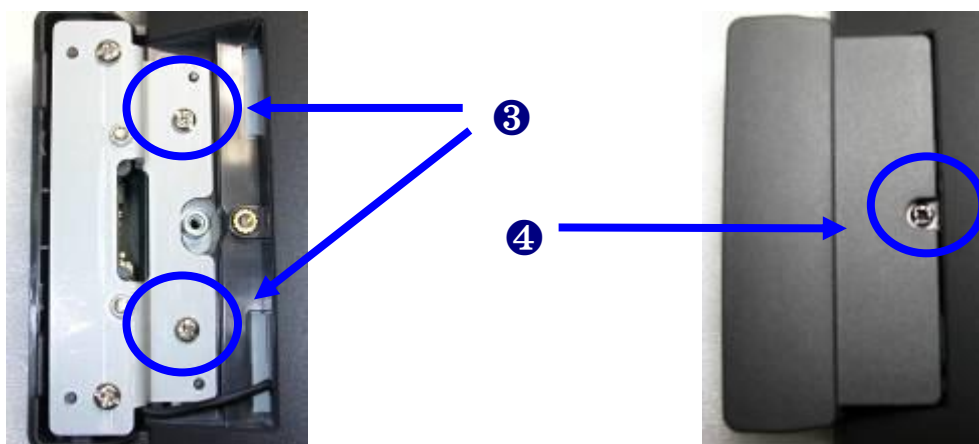
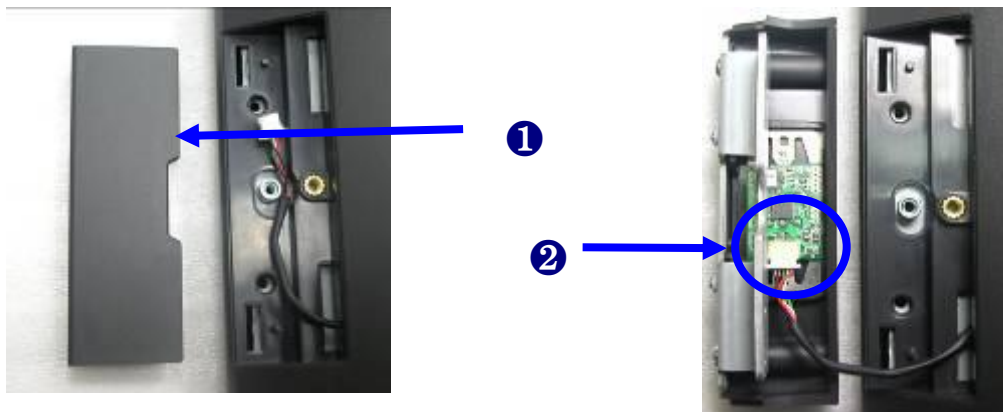

1. **Open the MSR back cover.**
2. **Connect the USB cable.**

3. **Fasten the screws (x2).**
4. **Close the MSR back cover and fasten screw (x1).**

➤ **Customers Display (optional)**

Components of Customers Display Kit:



**Customers
Display**



1. **Remove the screws (x3).**
2. **Open the Hinge Cover and I/O Cover**



3. **Connect the Customers Display cable to the COM port of the monitor.**
4. **Place the Hinge Cover onto the rear side of the display.**

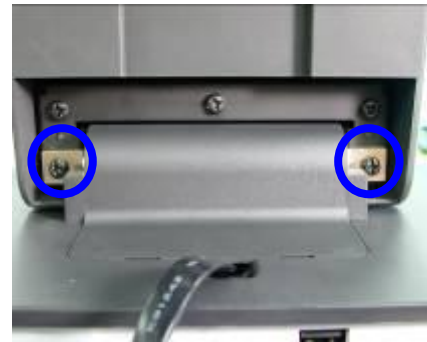

- 5. Fasten the screws (x2) to fix the Customers Display bracket to the Hinge bracket.**
- 6. Fix the Stand by fasten the screws (x2).**



➤ Control Buttons



Auto Adjusting	<p>a.) Pressing to execute AUTO-Adjusting function. This function will set the monitor display area to the optimal position.</p> <p>b.) Sometimes this function can't achieve the optimal effects. Please follow the manual adjusting procedure.</p>
Menu	<p>When the light bar move other item, the key are used to select it, and read to adjust. Press the MENU key to activate the On Screen Display (OSD). Press twice to turn off the OSD. After 30 sec idle time, the OSD screen will automatically turn off.</p>
Power	<p>Use the power switch to turn the power ON or OFF. We recommend to turn your system power on first, then the LCD monitor.</p>
Up	<p>a.) When OSD mode is activated (When "MENU" key is pressed). The two keys are used to select the adjustment items.</p>
Down	<p>b.) When adjustment item is selected, the two keys are defined to decrease or increase the value of each selected item.</p>

➤ **Structure of OSD settings**

	First Level	Second Level	Third Level	Operating Procedure
Main Menu	Auto Adjust			Press "UP" or "DOWN" to adjust H-phase & H-position & V-position clock automatically.
	Luminance	Brightness Contrast Exit		Press "UP" key to increase brightness, "DOWN" key to decrease brightness. Press "UP" key to increase contrast, "DOWN" key to decrease contrast.
	Geometry	H. Position V. Position Clock Phase Exit		Press "UP" key to shift screen right, "DOWN" key to shift screen left. Press "UP" key to shift picture upward, "DOWN" key to shift picture downward. Adjust sampling clock of analog to digital converter until clock is equal to pixel frequency of video input. By varying this "UP" "DOWN" control the exact sampling time within the pixel can be adjusted.
	Color	9300K 6500K 5800K		Press "UP" or "DOWN" to choose three types of color temperature 9300°k, 6500°k and user define.
		User Preset	Red Green Blue Exit	
		Exit		
	OSD	H. Position V. Position OSD Timeout Exit		Adjust OSD frame horizontal location, press "UP" key to shift frame right, "DOWN" key to shift frame left , timeout and preset OSD. Adjust OSD frame vertical location, press "UP" key to shift frame upward, "UP" key to shift frame downward , timeout and preset OSD.
	Language	English French German Italian Spanish Japanese T. Chinese S. Chinese		Press "UP" or "DOWN" to choose any one of the following language, English, French, Germany, Italy, Spain , Japanese, Traditional Chinese and Simplified Chinese.
	Recall	Color Recall Recall All Exit		Recall the default value.
	Miscellaneous	Sharpness Display Information Exit		Press "UP" key to increase sharpness, "DOWN" key to decrease sharpness.
Exit				

IV. For your safety

1. When move the monitor, always switch off power and disconnect all cables to avoid any danger.
2. Please use the power and signal cables correctly when install or bend it.
3. In case of notice any abnormal smell or noise, please stop operation and call the nearest dealer or service center.

V. Support timing chart:

Timing Mode	Reference Standard	Resolution	Pixel MHz	FH KHz	FV Hz	Interlace	H Polarity	V Polarity
Mode 1	VESA	1024x768	65.000	48.363	60.004	NO	-	-
Mode 2	VESA	1024x768	75.000	56.476	70.069	NO	-	-
Mode 3	VESA	1024x768	75.011	57.524	72.000	NO		
Mode 4	VESA	1024x768	78.750	60.023	75.029	NO		

VI. Mechanical Dimension

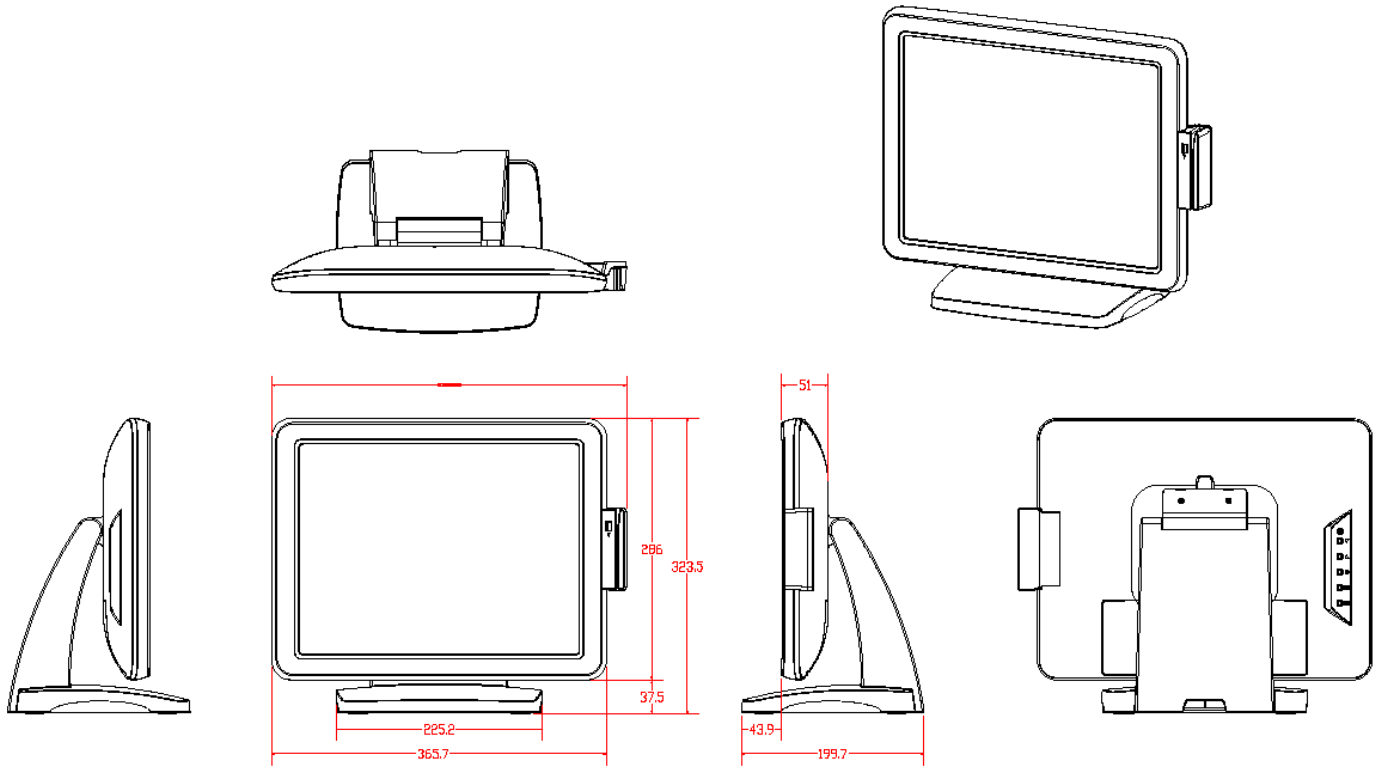

VII. Product General Specification

Model	EC150
Cabinet color	Black
Display size	15.0"
Active Area	304 * 228 mm
Optimal Resolution	1024 * 768
Color Arrangement	RGB-stripe
Brightness	250 cd/m ² (typ)
Contrast Ratio	600:1
Response Time	8 ms (typ)
Viewing Angle	160 degrees (H) 160 degrees (V)
Input Video Format	VGA/DVI
Input Video signal connector	VGA(D-Sub 15 pins), DVI-D
Power consumption	20W
Input Frequency	Horizontal : 31.5 kHz~60.2 kHz Vertical : 56.3Hz~75Hz
Power supply	DC 12V +/- 10%
Temperature	Operating : 0°C~40°C Storage : -10°C~50°C
Humidity	Operating : 20%~80% Storage : 10%~90%
Weight	4.6kg(net)
Approvals	CE, FCC
Wall Mount	VESA 75 * 75 mm